

SF-RAD:

Development and Proof-of-Concept Implementation of the South Florida Miami RADx-rad SARS-CoV-2 Wastewater-Based Surveillance Infrastructure

Presented by:
Helena Solo-Gabriele, PhD
University of Miami



**Weill Cornell
Medicine**

Funded by
NIH RADx-rad Grant
1U01DA053941-01

SARS-CoV-2 Wastewater-Based Surveillance

Overview

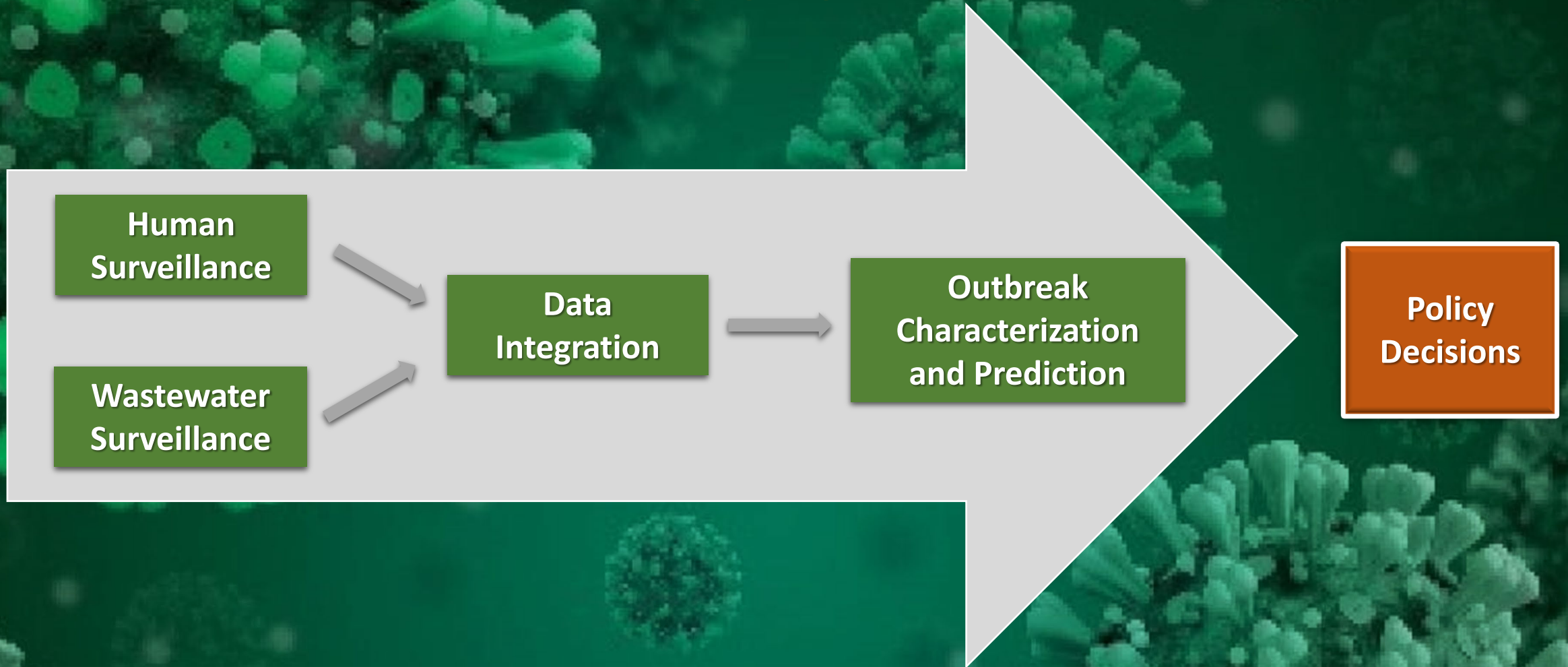

SF-RAD: SARS-CoV-2 Wastewater-Based Surveillance

Administrative Organization and Leadership

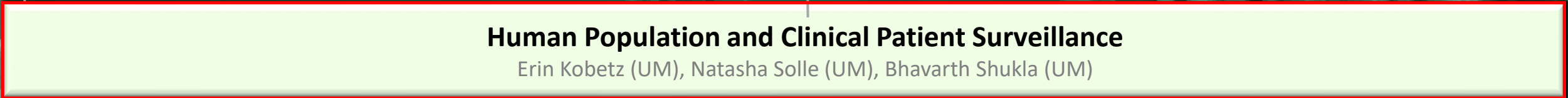
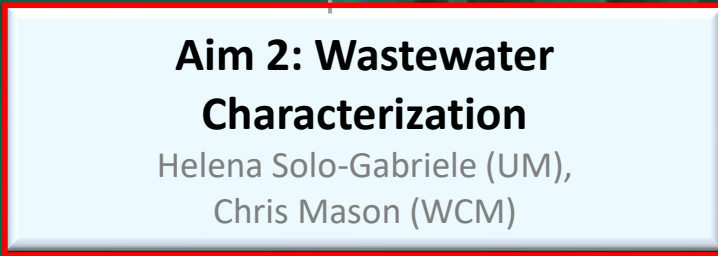
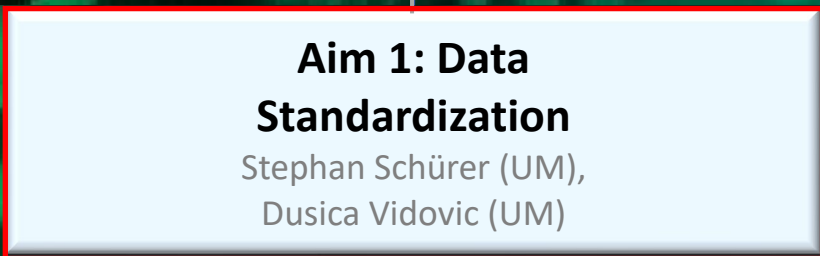
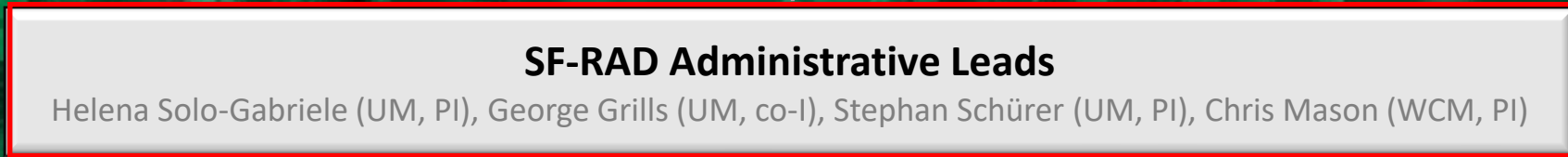
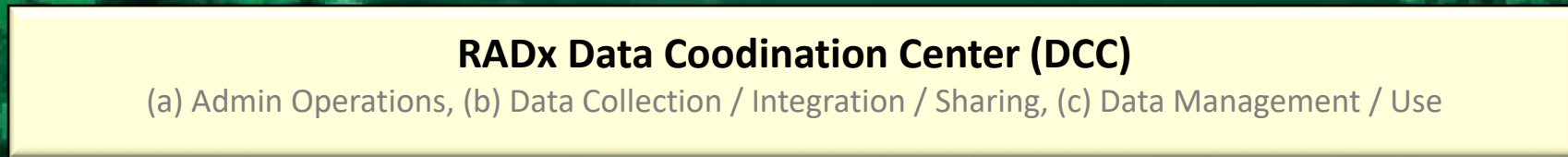

Human Surveillance

Academic Campus

- Students tested weekly (nasal swab, qPCR)
Supplemented by breath test
- Faculty tested randomly
- Positives by building
- Number of positives and total no. tests

University Hospital

- Treat COVID patients
- Known number of patients
- Electronic medical records (IRB)
- Biobanking of biospecimens

Miami-Dade County (FDOH)

- Positives by zip code
- Number of tests by zip code

Results: 4-day prediction (Sharkey et al. 2021)

Sample Collection Plans

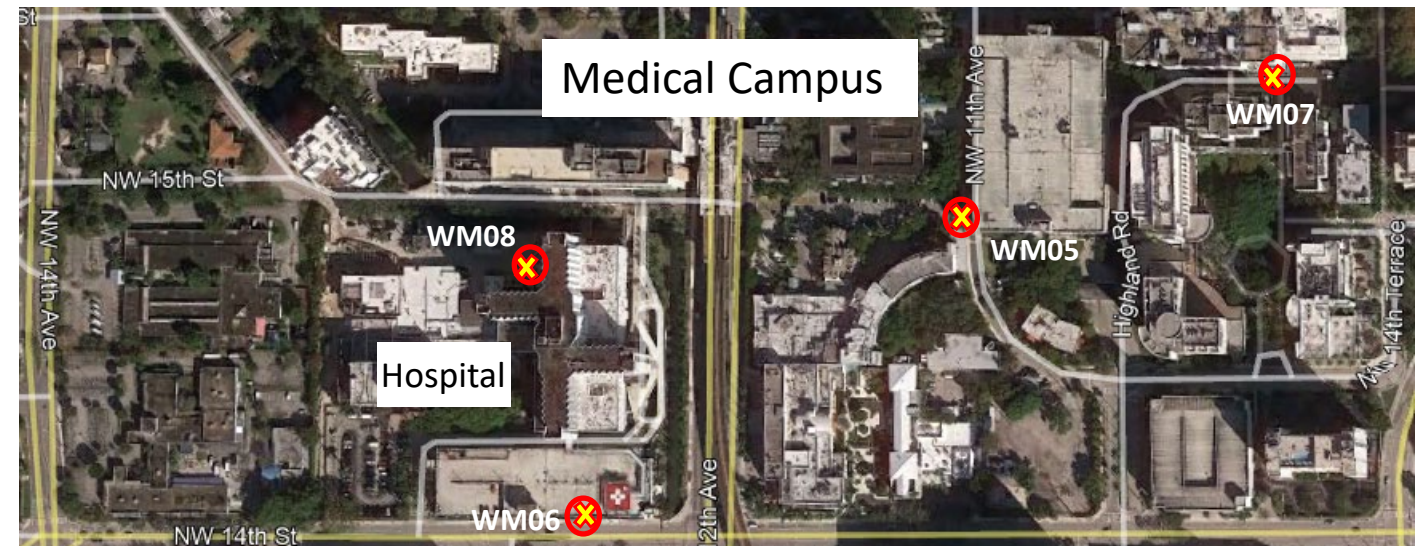
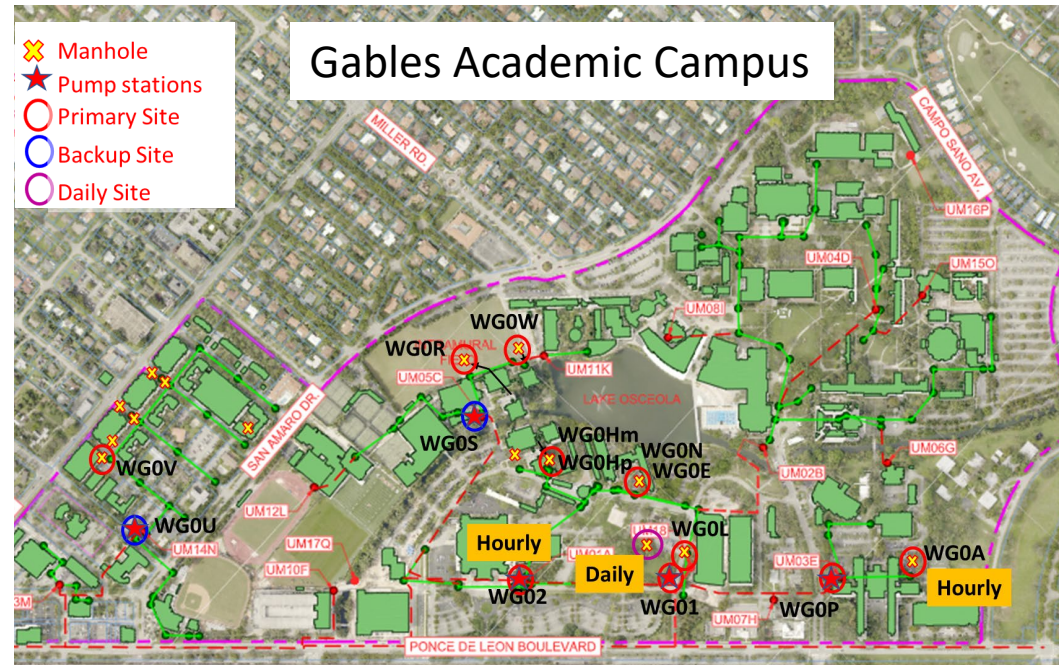



Aim 2, Wastewater Characterization:

- *Evaluate Sample Concentration Methods*
- *Evaluate Sample Collection Methods (grab vs composite).*
- *Evaluate influence of watershed scale.*



Wastewater Sampling

➤ ***Where do we sample wastewater from?***

- Manholes (building scale)
- Pump Stations (cluster)
- Wastewater Treatment Plant

➤ ***How do we collect the wastewater?***

- Chain and bottle (grab)
- Automatic sampler (composite)
 - Samples on each hour, the entire day- 24 hours



Watershed Scales

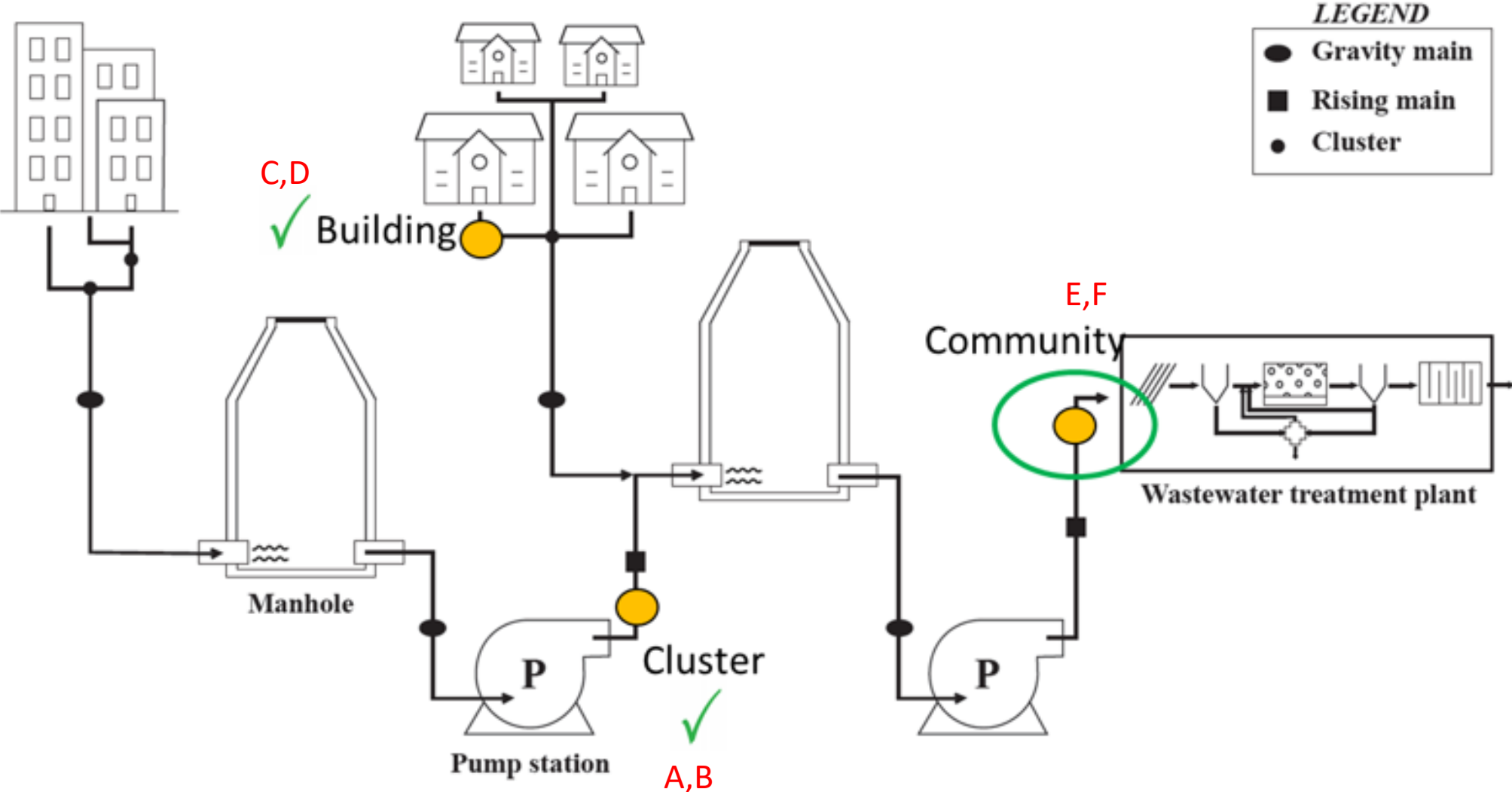

Experimental Design

Experiments
B, D, F

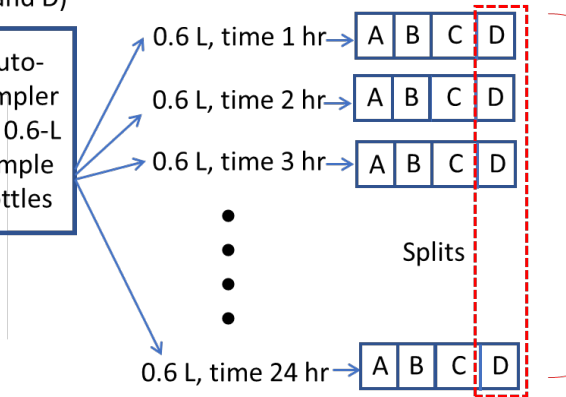
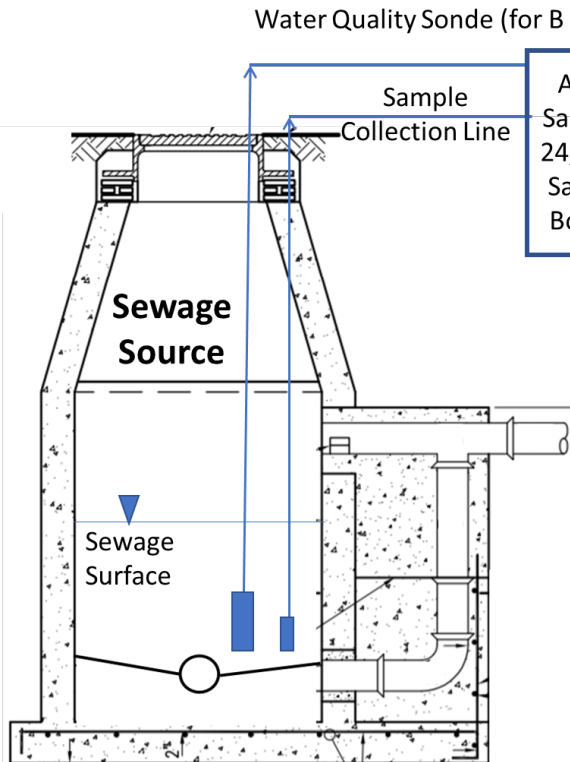

Split A: 100 mL for Concentration and Extraction
Split B: 10 mL for Fecal Coliform
Split C: 390 mL for Water Quality (T, pH, SPC, DO, Turb)
Split D: 100 mL for Composite

Experiments
A, C, E

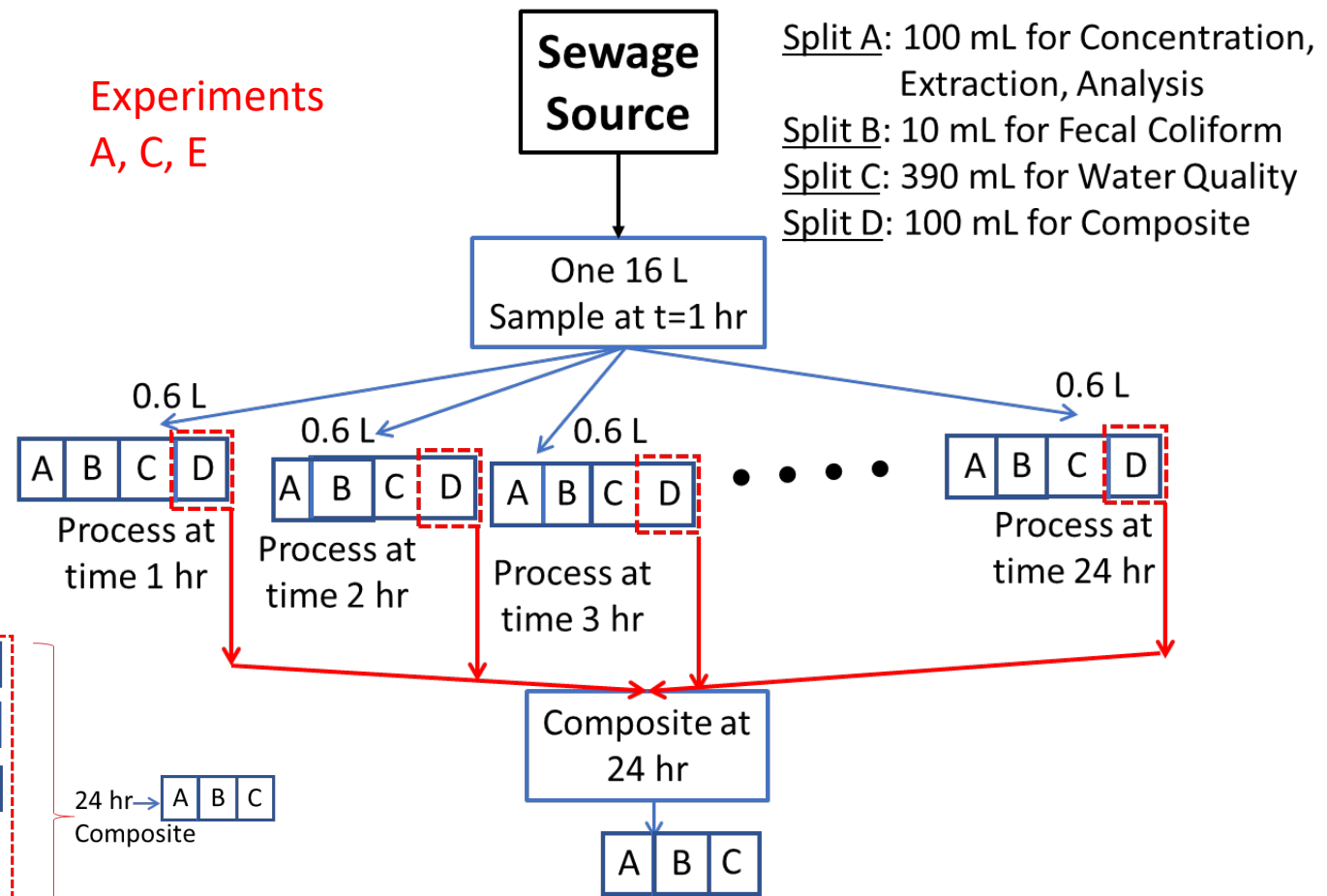

Compare degradation of SARS-CoV-2

Hour-to-hour variability



Sample Analysis Plan (Hourly Sampling)

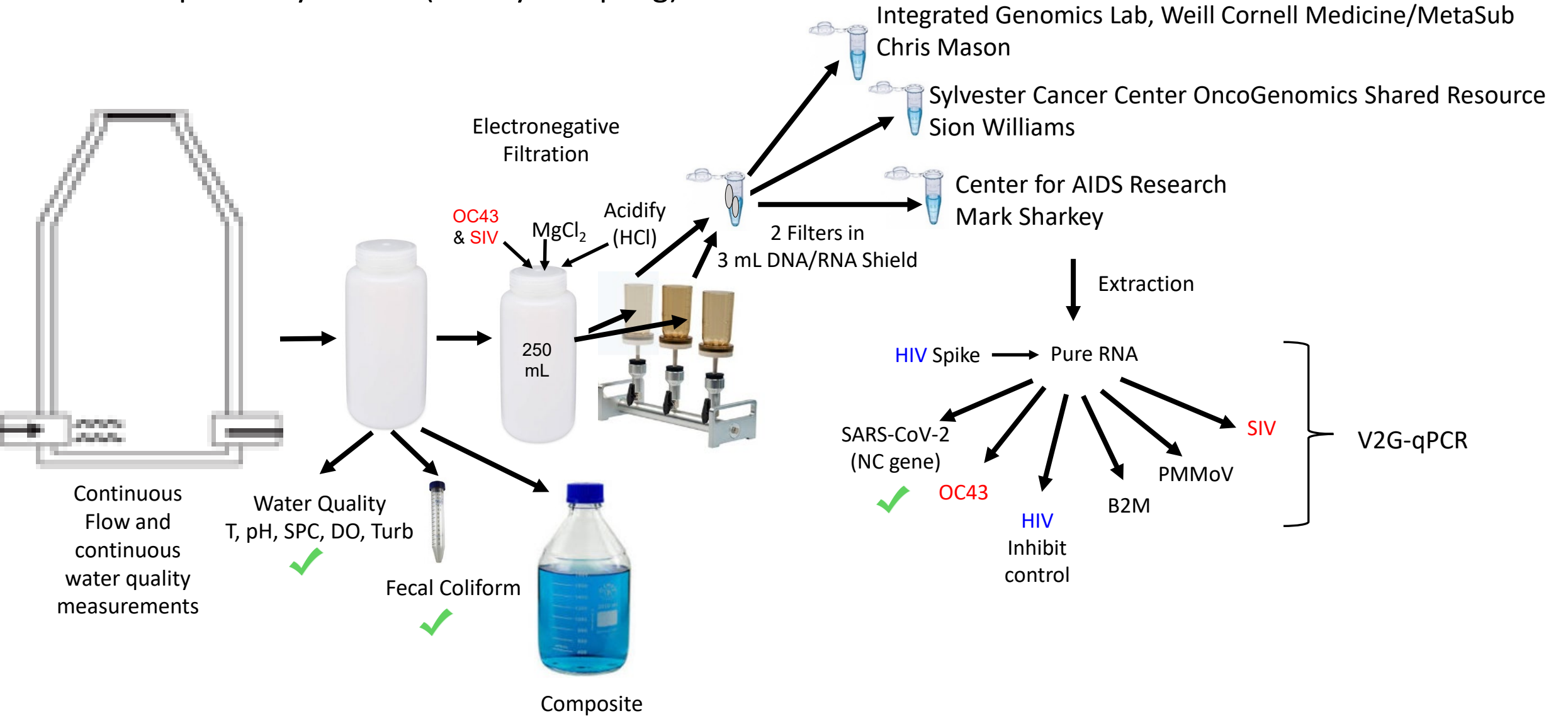

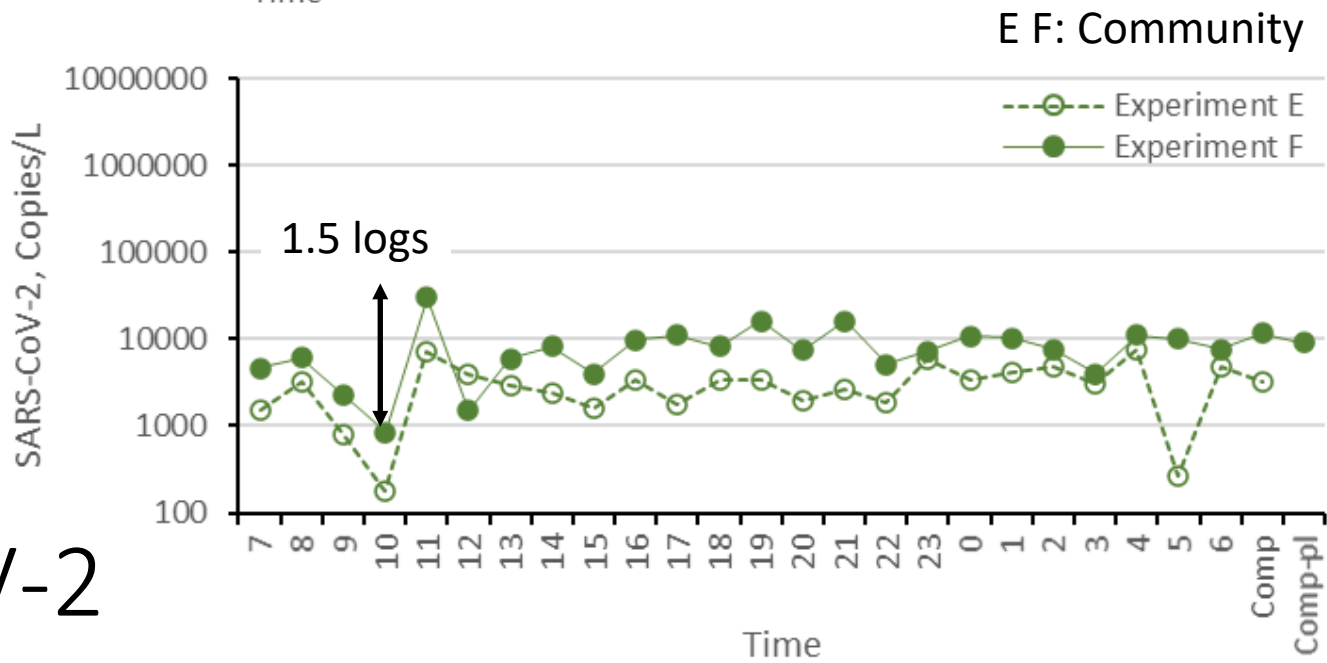
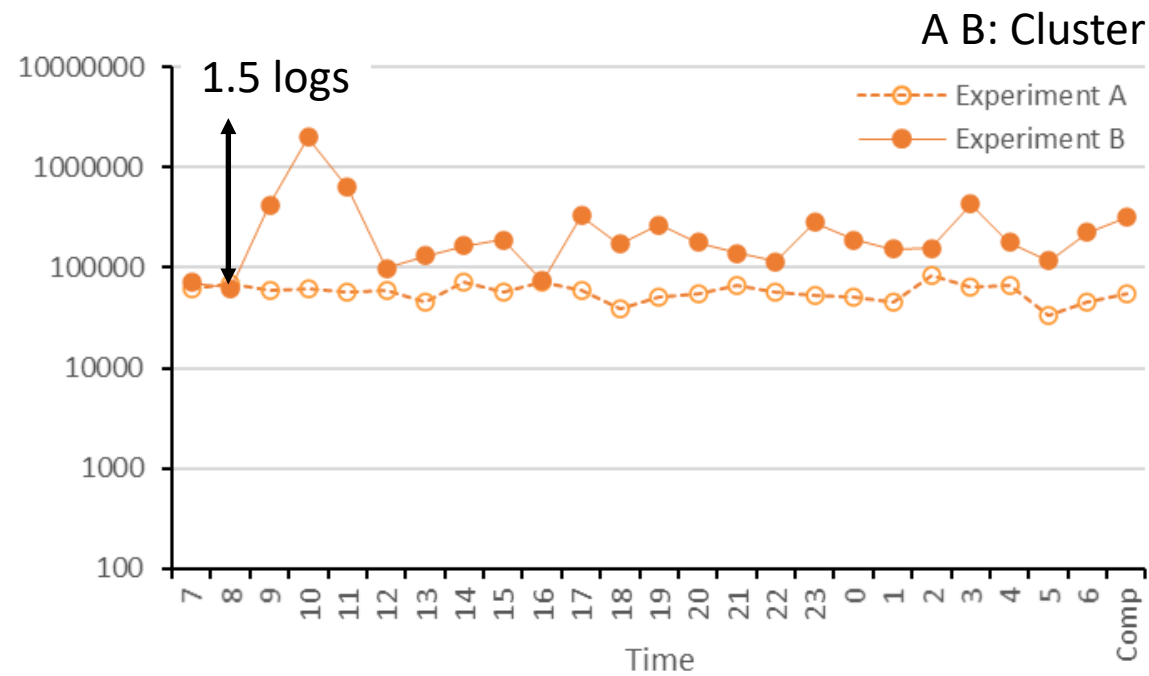
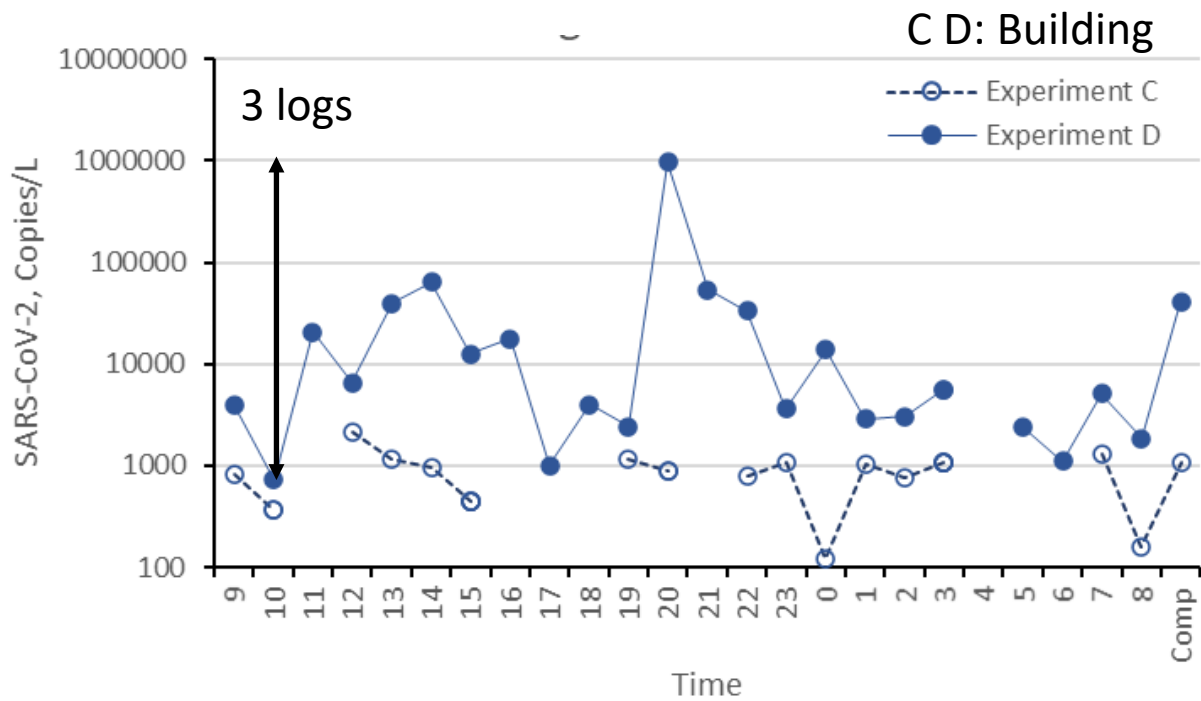

SARS-CoV-2

Conclusions

Thank you
(hmsolo@miami.edu)

- Wastewater in sewer variable.
 - 3 log-10 variation in SARS-CoV-2 observed at building scale
 - 1.5 log-10 variation in SARS-CoV-2 observed at cluster and community scale
- Degradation at room temperature, secondary
- Fecal coliform shows evidence of multiplication in sewer
- Specific conductivity correlated with fecal coliform at building scale

Next Steps

- Complete analysis of remaining targets including metagenomics
- Run statistics